**DESCRIPTION**

The Altec 31B Sectoral Horn uniformly controls the sound projection angle and maintains excellent reproduction in the middle and high frequencies. Inexpensive and compact, the 31B is designed for speech and music reproduction in sound systems where wide angles of horizontal coverage and/or a low cutoff frequency are required. Applications include indoor or outdoor use in paging systems, factories, airports, arenas, stadiums, shopping centers, parking lots, two-way loudspeaker systems, theatres, auditoriums, restaurants, schools, churches, studios, concert halls, hotels, nightclubs, discotheques, and other wide range music systems.

A characteristic of a sectoral horn is that the horizontal beam width remains constant throughout the middle and high frequency range. In other types of horns, the beam becomes progressively sharper as the frequency increases until, at the higher frequencies, only a narrow area may be covered adequately. Because the dispersion pattern is controlled by the sectoral expansion, the full sound spectrum may be directed exactly where needed—and without the spray effect or horizontal diffraction usually found in folded or re-entrant horns.

Long acoustic length and 300 Hz cutoff adapt the 31B to high level operation with excellent projection. Distribution pattern is 120 degrees

horizontally and 40 degrees vertically. Construction is of light weight cast aluminum, carefully designed for complete freedom from resonance and ring. The single 90-degree bend permits compact and secure attachment to a pole or other vertical surface. A flange permits the 31B to be mounted in a cabinet or enclosure.

With the 27A adapter the 31B horn may be driven by an Altec Lansing 731C, 902-8B, or 908-8B compression driver. High-pass filtering is required for all of these. The 731C is the preferred driver if the 31B alone must reproduce speech.

SPECIFICATIONS

**Sound pressure level at 4',
with 731C driven by pink
noise band limited 0.5-3
kHz (ref.: 20 μ Pa)**

One watt:	102.5 dB-SPL
60 watts:	118.5 dB-SPL

Distribution Pattern—

Horizontal:	120°
Vertical:	40° Hz

Cutoff Frequency: 300 Hz

Dimensions— See Drawing on back.

Weight—

31B (shipping weight):	15.0 lbs (6.8 Kg)
31B (net weight):	13.5 lbs (6.1 Kg)
with 731C driver:	21.0 lbs (9.5 Kg)

Color: black

Accessories: 27A throat adapter for 731C, 902-8B, or 908-8B drivers. 15480 matching transformer with high-pass filtering.

Dispersion Angle vs Frequency

This graph displays the horizontal and vertical directivity control of the 31B Horn.

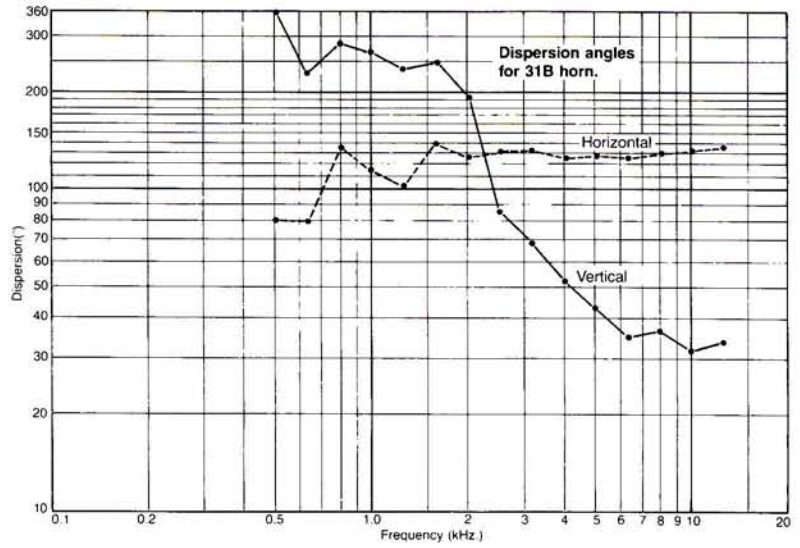

Unequalized Frequency Response

with Altec Lansing 731C Driver

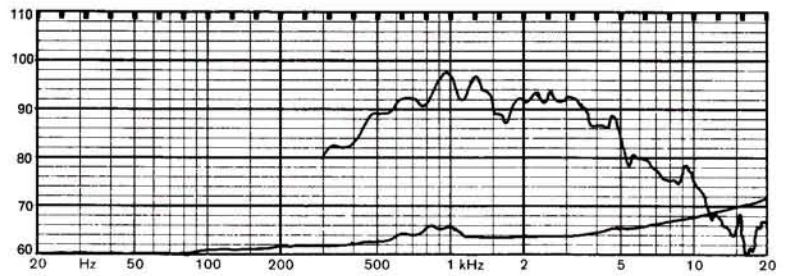

Q and D1 vs Frequency (D1 = 10 Log Q)

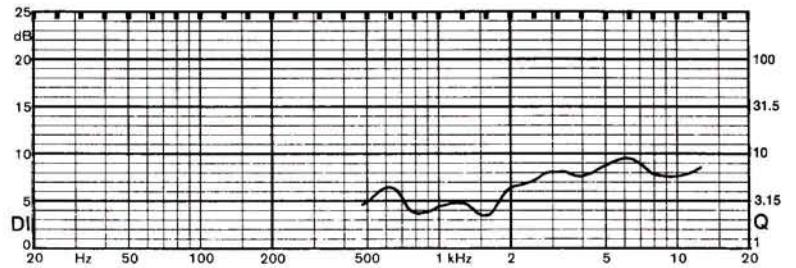

Polar Response Charts (using 1/3 octave bands of pink noise)

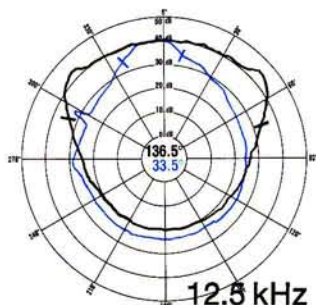
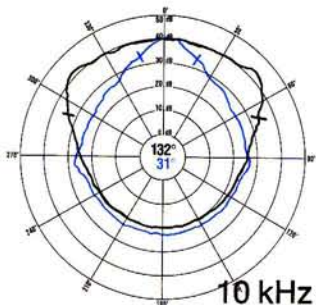
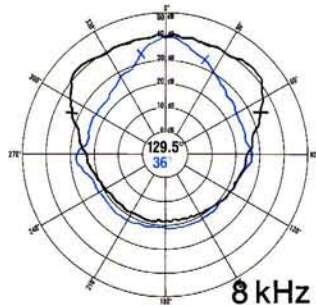
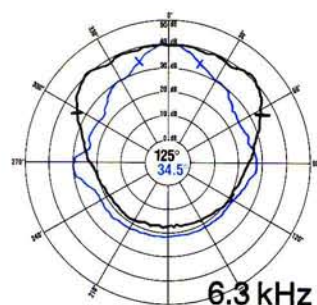
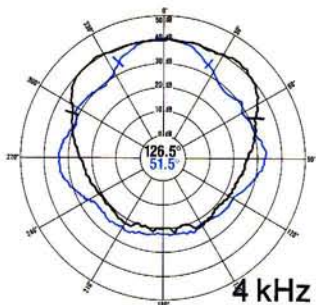
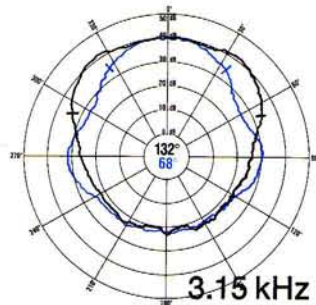
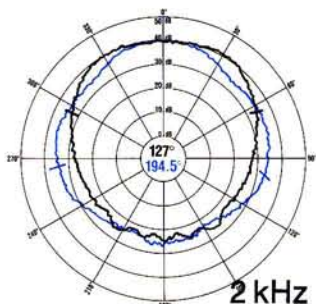
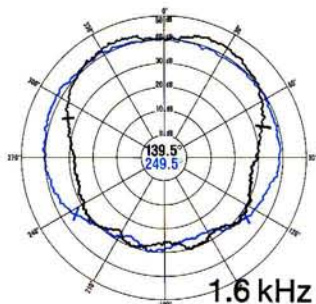
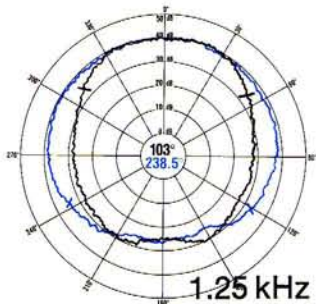
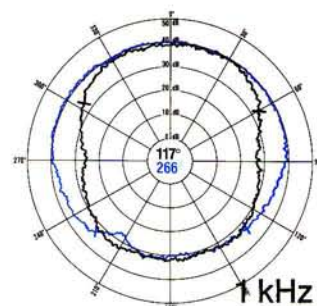
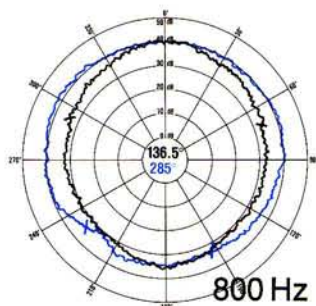
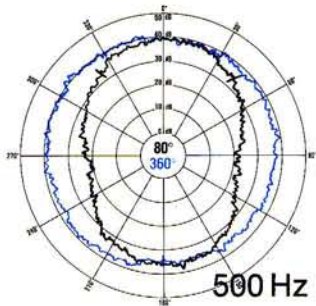

HORIZONTAL
VERTICAL

ROW 1 (1 : 4)



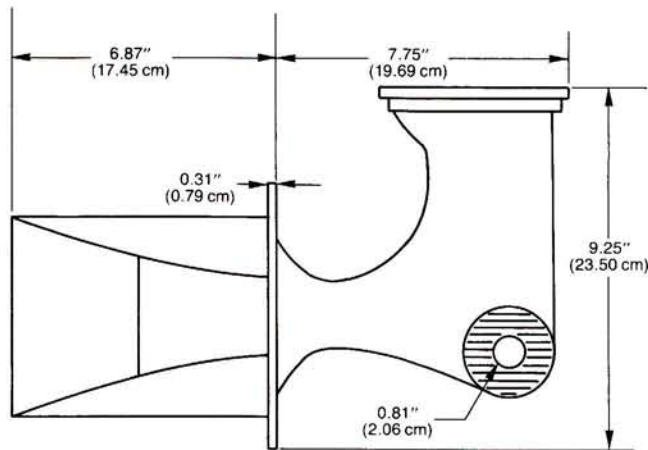
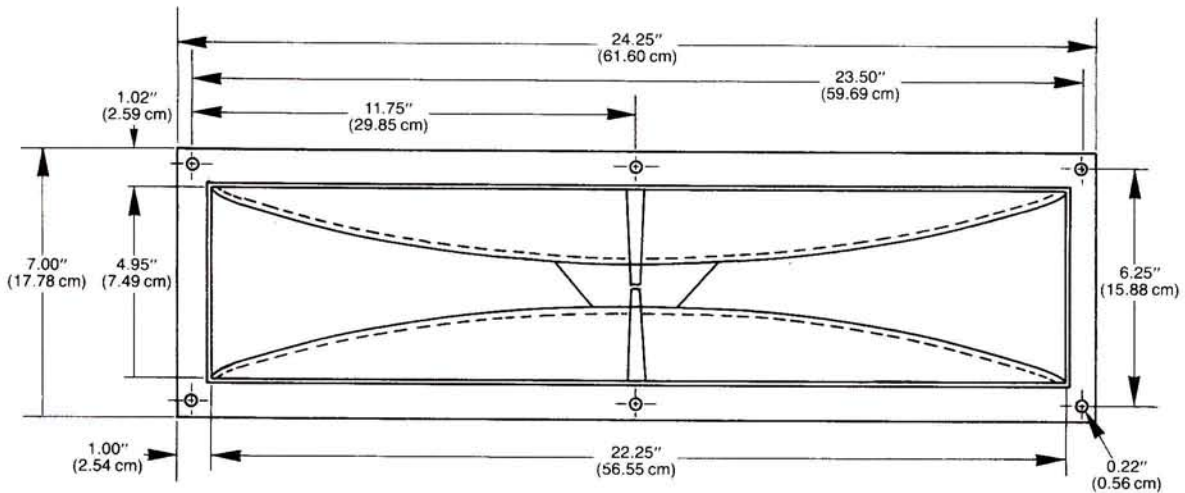
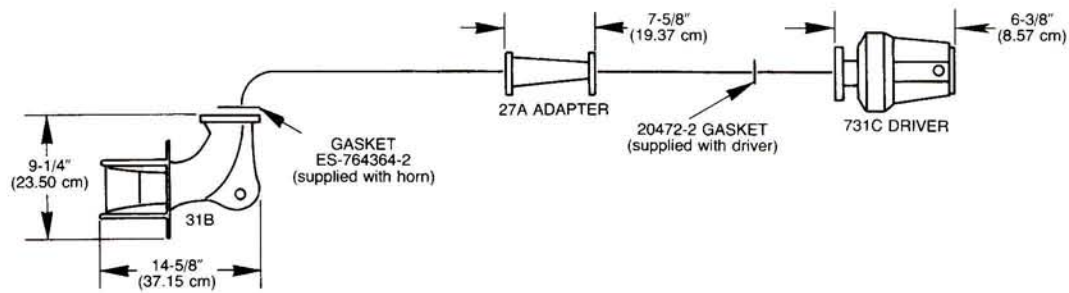

ARCHITECT'S AND ENGINEER'S SPECIFICATIONS

The loudspeaker horn shall be furnished complete with 27A receiver attachment. It shall be of the wide-angle, sectoral type and shall employ not more than one bend of not over 90°. Folded or re-entrant type horns will not be acceptable under this specification, and horns not of the sectoral type will not be acceptable. When equipped with the compression type driver specified

elsewhere, it shall produce a uniform sound pressure level of _____ dB at a distance of 10 feet for a one watt input. The distribution angle shall be 120° horizontally and 40° vertically. It shall have a low frequency cutoff of 300 Hz and shall be constructed of cast aluminum.

The horn shall be Altec Model 31B.



a gulton company
 10500 WEST RENO AVENUE
 P.O. BOX 26105, OKLAHOMA CITY, OK 73126-0105